

Pressione dinamica minima di utilizzo 0,5 bar.  
Minimum dynamic pressure of use: 0,5 Bar.

PORTATE A PRESSIONE DINAMICA SENZA LIMITATORE  
FLOW RATES AT DYNAMIC PRESSURE WITHOUT LIMITATION SYSTEM

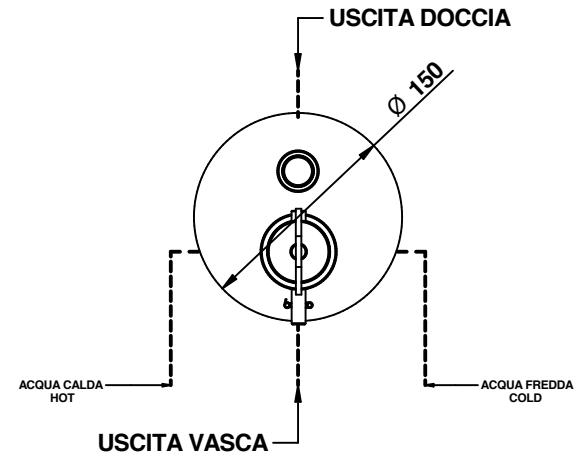
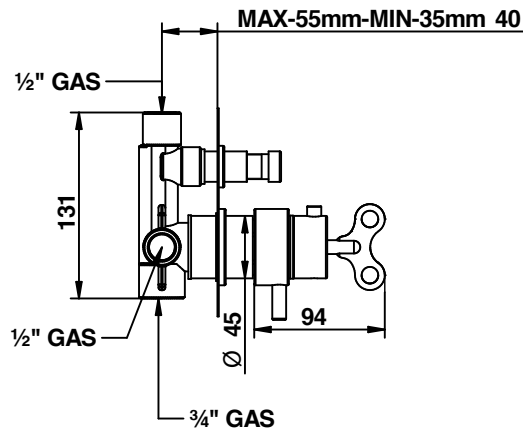
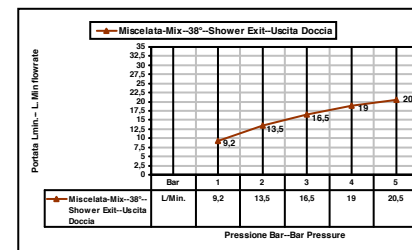
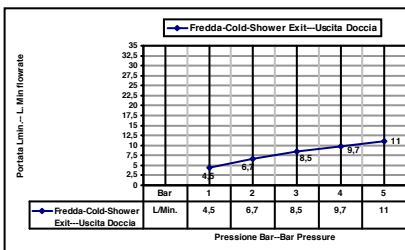
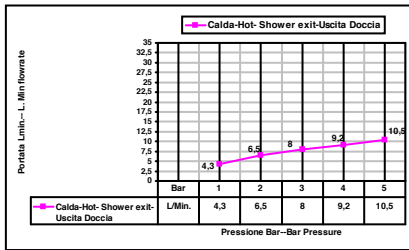
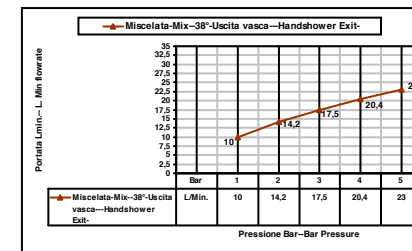
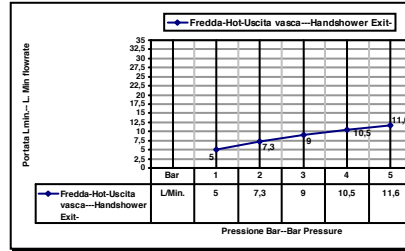
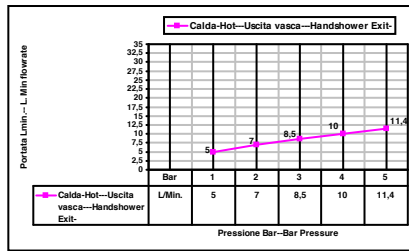

Cod. 63549CRPR  
Acqua Carica

Termostatico incasso coassiale 1/2"  
con deviatore

Built-in coaxial 1/2" thermostatic mixer  
with diverter

© Copyright of Bongio s.r.l.

**bongio**

Mario Bongio s.r.l.  
Via Aldo Moro, 2  
28017 San Maurizio d'Opaglio (NO) - Italy  
tel: +39 0322 967248 fax: +39 0322 950012  
www.bongio.com