



**DANIEL**

SCHEDA TECNICA TECHNICAL FEATURES

ART. COD.

**S20678**

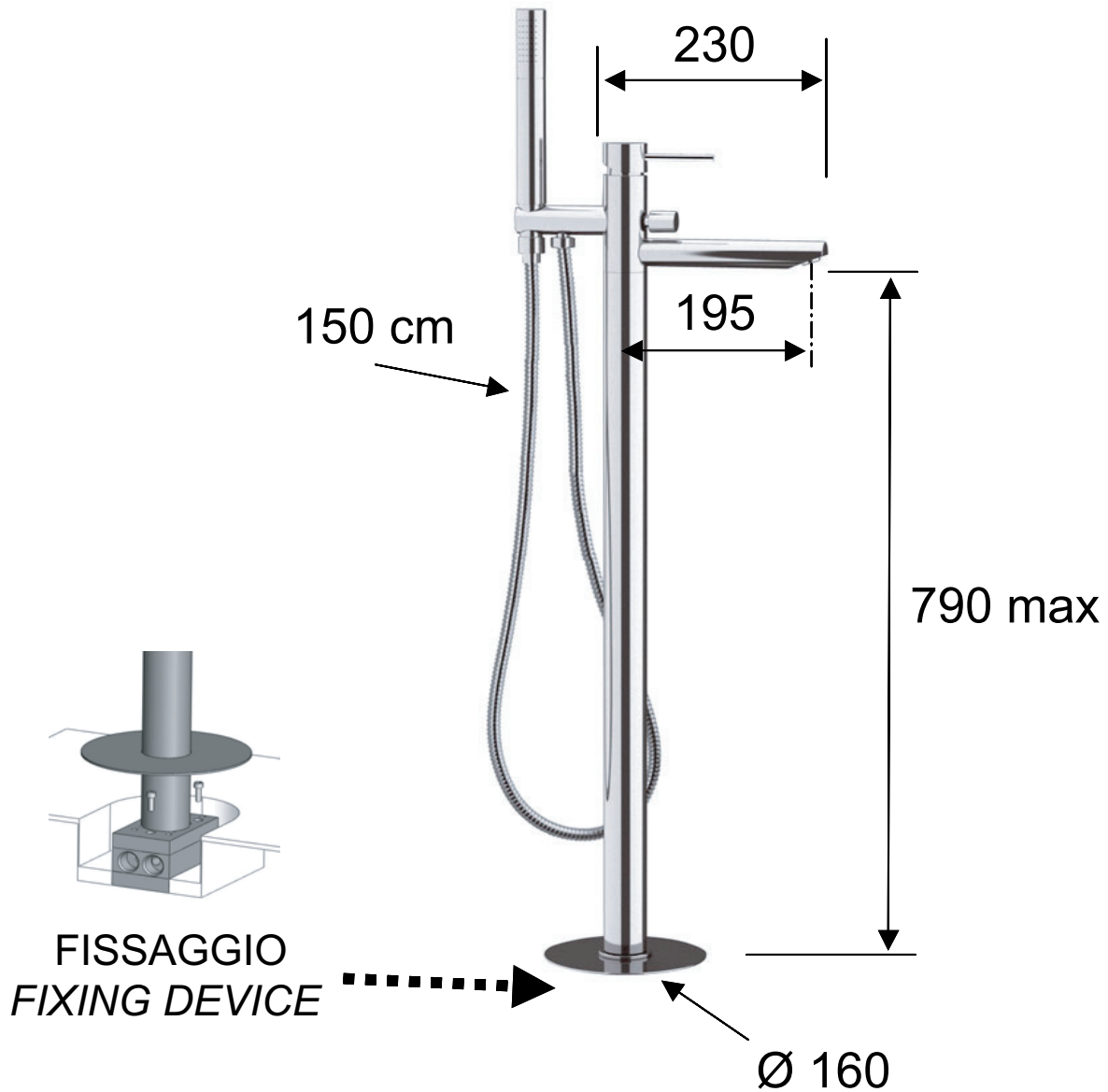

**MATERIALI / MATERIALS**

OTTONE CROMATO / CHROME PLATED BRASS

**CROMATURA / CHROME PLATING**

UNI EN 248

Via Leonardo da Vinci 53 20062 Cassano d'Adda (MI) Italy Tel. +39-0363 62651  
info@daniel.it www.daniel.it