

LED RGBW
POWER SUPPLY 350 mA
NOMINAL POWER 4,2 W
WHITE LED TEMPERATURE 6500 K
MINIMAL FLUX WHITE LED 100 lm
LED VIEWING ANGLE TYPICAL 130°

INC18

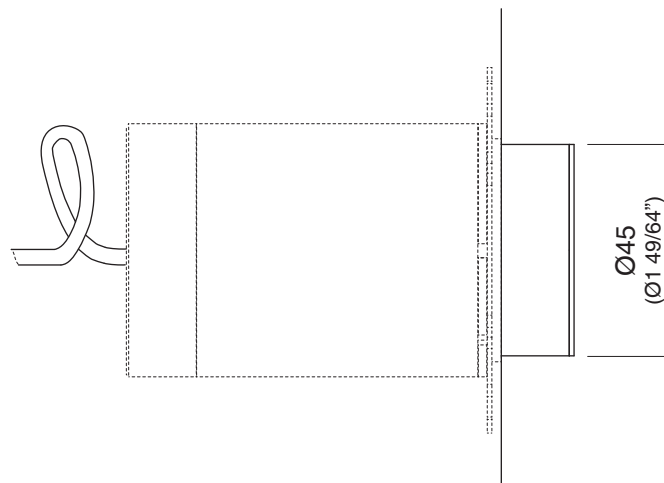

FRE164 _REV1.1

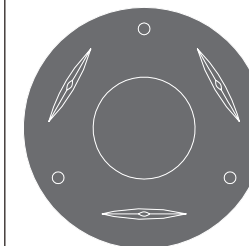

FRE164/FREE IDEAS

AISI 316/L STAINLESS STEEL

Soffione doccia ad incasso con estremità in Delrin®, getto spray e LED cromoterapia

Built-in shower head with Delrin® end, spray jet and LED chromotherapy

CEA DESIGN STUDIO

PRODOTTI CORRELATI / RELATED PRODUCTS

BOT01 - ELC01

Prodotto che necessita di collegamento elettrico
Product that needs electrical connection

Prodotto che necessita di parte incasso
Product that needs built-in part

MANUTENZIONE / MAINTENANCE

NON UTILIZZARE DO NOT USE		acido clorico e muriatico <i>cloric and muriatic acid</i>
		acido fluoridrico <i>hydrofluoric acid</i>
		ipoclorito di sodio <i>chlorine bleach</i>
UTILIZZARE TO USE		sapone a PH neutro <i>neutral PH soap</i>

Questi disegni sono proprietà di CEADDESIGN SRL s.u. pertanto non potranno essere utilizzati e/o comunicati a terzi, anche in forma parziale, senza preventiva autorizzazione. CEADDESIGN SRL s.u. si riserva il diritto di apportare modifiche ai disegni al fine di migliorare il prodotto.

CEADDESIGN SRL s.u. has the property rights on these drawings, therefore they cannot be used and/or transferred to third party, even in partial form, without any prior authorization. Furthermore CEADDESIGN SRL s.u. reserves the right to apply any change to these drawings in order to upgrade the product.

CEA

ceadesign.it

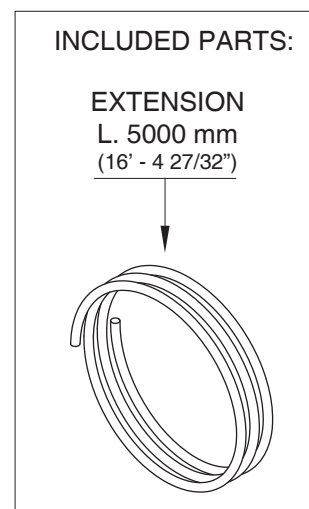
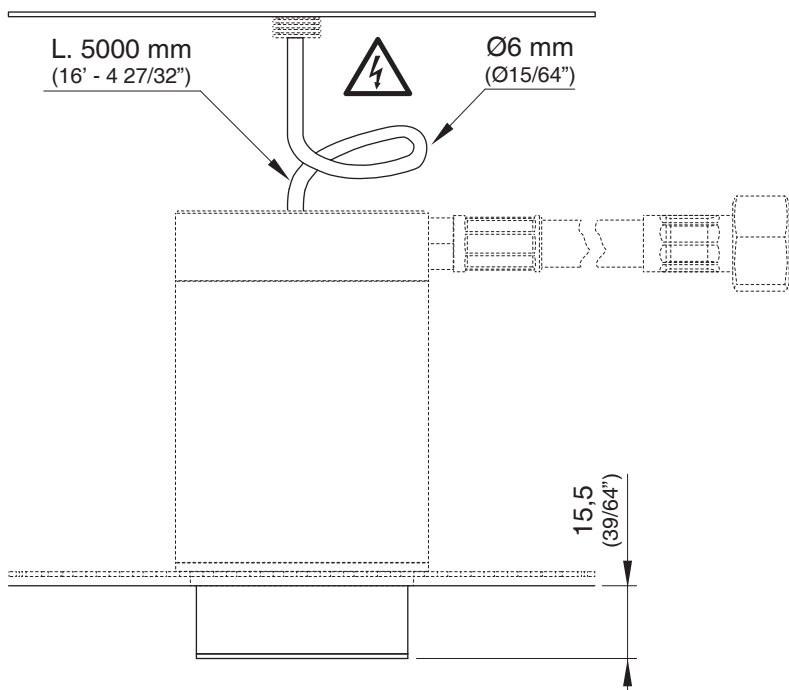

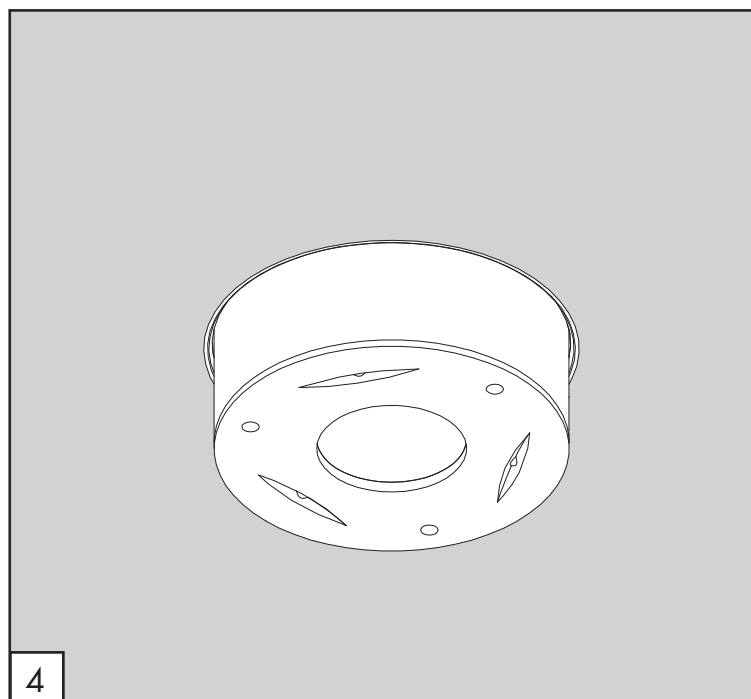
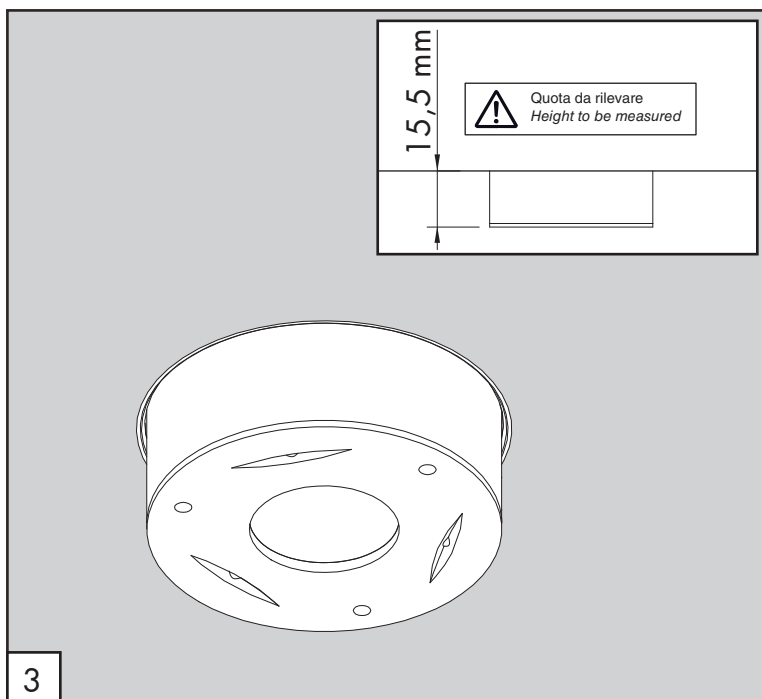
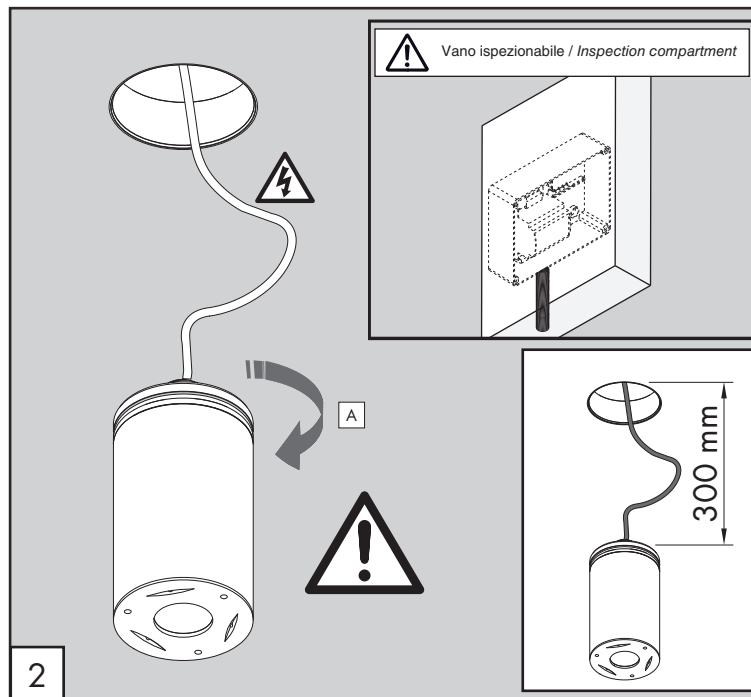
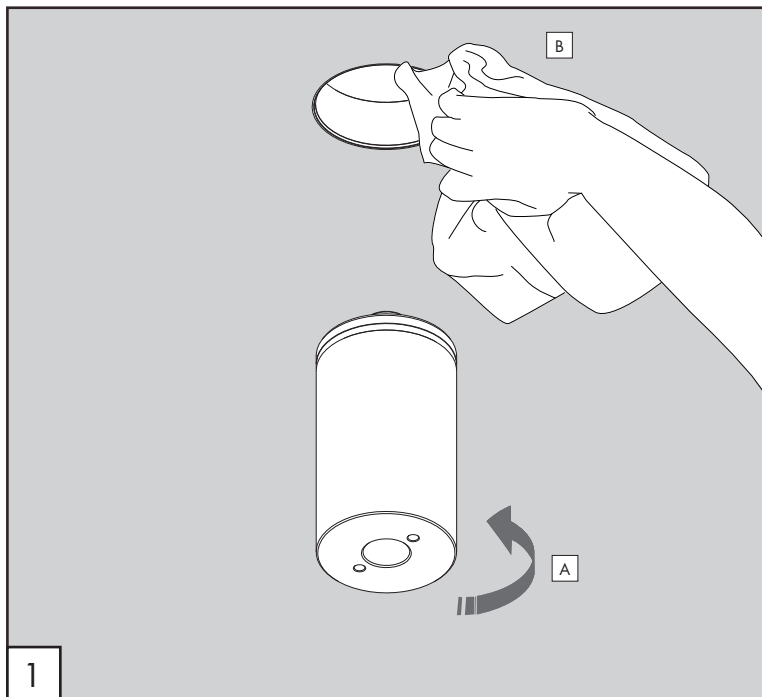

AVVERTENZE TECNICHE

Risciacquare bene le tubazioni prima del montaggio ed evitare sbalzi di pressione.
Mantenere integro il filo elettrico durante la fase di montaggio.
Realizzare a regola d'arte i collegamenti elettrici al fine di non compromettere la corretta alimentazione del Led.

TECHNICAL WARNINGS

The pipes have to be rinsed thoroughly before installation to avoid pressure differences.
Please maintain intact the electric cable during the assembling process.
Please realize the electrical connection compliant to regulation to avoid any compromise to the LED electricity supply.

TECHNISCHE WARNUNG

Spülen Sie die Leitungen vor dem Einbau und verhindern Sie Wasserdruckwechsel.
Während der Montage, halten Sie das Kabel unversehrt.
Die elektrischen Verbindungen müssen einwandfrei realisiert werden, um die korrekte Versorgung der LED nicht zu gefährden.

ADVERTENCIA TÉCNICA

Purgar bien las tuberías antes de la instalación y evitar cambios bruscos de presión.
Mantener íntegro el hilo eléctrico durante la instalación.
Realizar correctamente las conexiones eléctricas para no comprometer la correcta alimentación del Led.

ADVERTISSEMENTS TECHNIQUES

Rincer les tuyaux avant l'installation. Eviter grandes différences de pression.
Préservez l'intégrité du câble électrique en phase de montage.
Réalisez à la lettre les branchements électriques afin de ne pas compromettre la correcte alimentation LED.

RICAMBI / SPARE PARTS

RICA089 Testa soffione / *Head shower disk*

RICE001 Componente elettrico / *Electrical component*

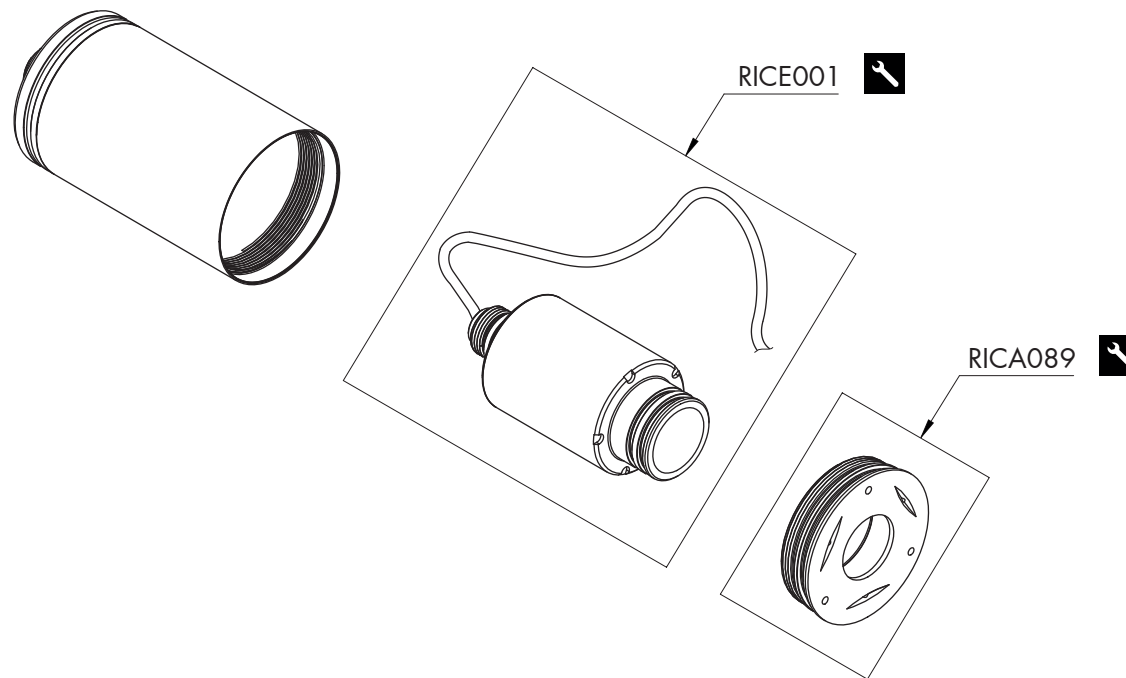

LEGENDA / LEGEND

ICONE / ICONS



Utensile incluso nel ricambio
Tool included in spare part