

**SHBA** ☒ □ ▱ ◐

Bacinella d'appoggio con troppo pieno

On top bowl with overflow

Cubela de apoyo con demasiado lleno







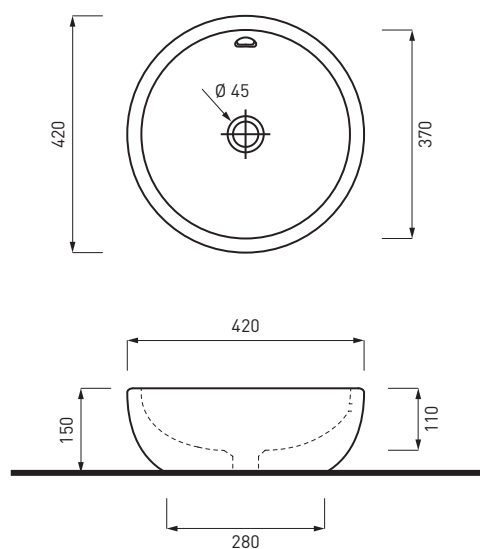









Vasque à poser avec trop plein

Aufsatzbecken mit Überlaufschutz

**Kg. 7,90**



## LEGENDA LAVABI E SANITARI / SINK AND SANITARY LEGEND

	senza foro rubinetto - no tap holes
	senza foro rubinetto su richiesta - no tap hole on request
	monoforo - one tap hole
	monoforo predisposto a tre fori - one tap hole, pre-arranged for three tap holes
	con un lato non smaltato - with one not enamelled side
	con i lati tutti smaltati - all enamelled sides
	installazione sospesa - wall mounted installation
	installazione d'appoggio - on top installation
	installazione a semi incasso - semi fitted installation
	installazione ad incasso - fitted installation
	installazione su colonna - on pedestal installation
	completo di curva tecnica o sifone - with technical joint or siphon
	completo di fissaggi - with fixing parts
	con troppo pieno - with overflow
	compatibilità combifix - combifix compatibility
	novità - news



Ceramica Cielo rispetta l'ambiente: la sua politica è mirata al risparmio dell'acqua. L'azienda infatti ricicla il 95% delle acque di lavorazione, attraverso sistemi di depurazione delle acque interne, e produce sanitari di alta gamma a risparmio di acqua. Infatti i sanitari di Ceramica Cielo contrassegnati da questo marchio funzionano con solo 4,5 Lt di acqua, a differenza di altri che necessitano di almeno 6 o 7 litri.

Ceramica Cielo respects the environment: its policy aim at saving water. Our factory recycles 95% of production water, thanks to an internal water cleaning system and our high quality sanitary wares are made for saving water, too. In fact, all Ceramica Cielo articles labelled with this mark have a discharge system that needs only 4,5 litres of water, instead of 6 or 7 litres as for other sanitary wares).