

SCHEDA TECNICA / TECHNICAL DATA

RUBINETTERIE RITMONIO S.R.L. si riserva tutti i diritti connessi con il presente documento e con l'oggetto o la materia ivi rappresentati con divieto di riprodurlo, utilizzarlo o renderlo accessibile a terzi in assenza di previa autorizzazione. Disegno CAD non modificabile a mano

RUBINETTERIE RITMONIO S.R.L. will claim all rights related to the present document and with the object or subject represented therein with the prohibition of reproduction, use or disclosure to third parties without previous permission. The Cad plan is not alterable by hand

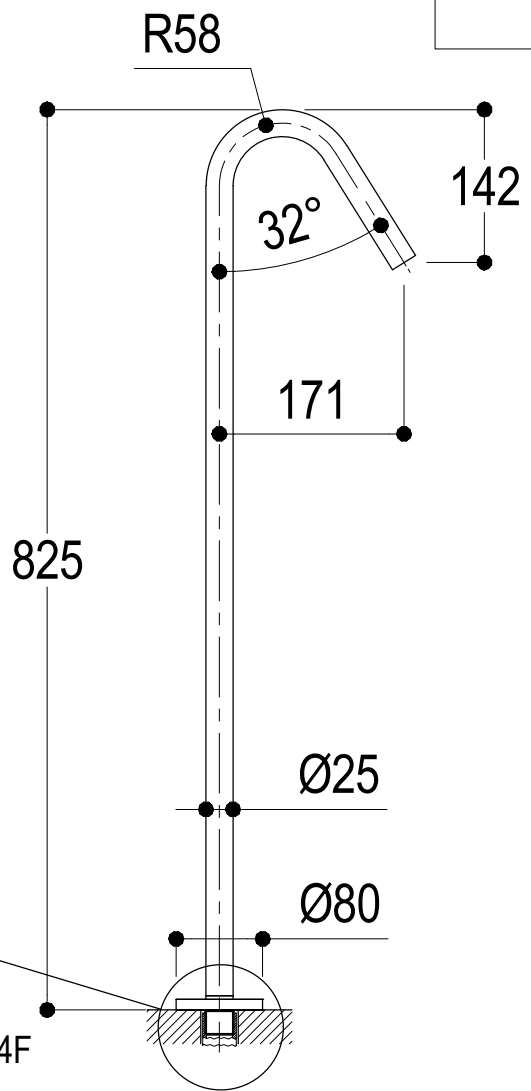
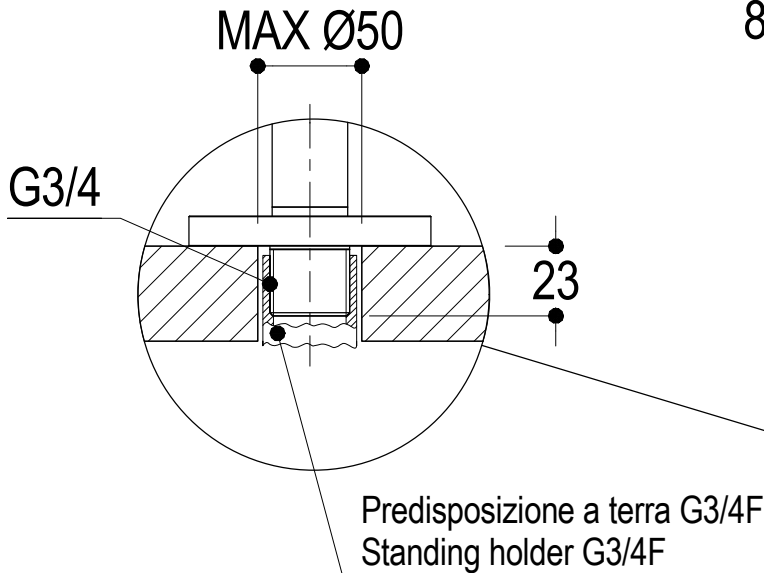
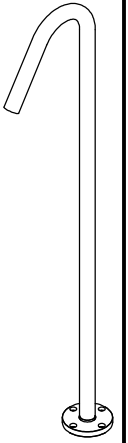
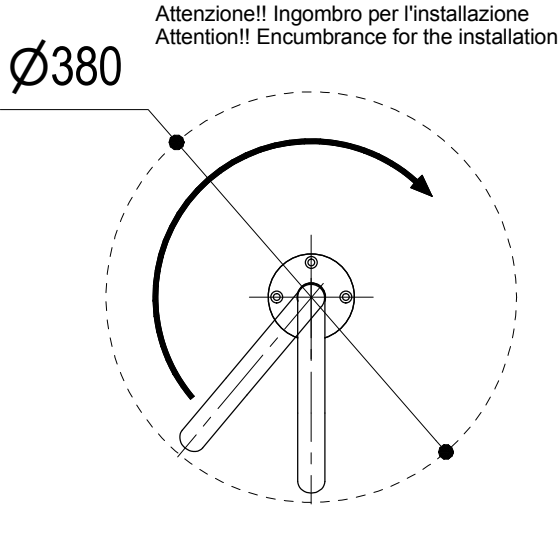

Ritmonio
Living a quality experience.
13019 VARALLO - (VC) - ITALY

SERIE Ø35 inox

CODICE E0BA0104H2

DATA EMISSIONE 18/05/15

DENOMINAZIONE Bocca di erogazione da terra
Standing floor spout

REVISIONE /

EMESSO SIGNORINI

APPROVATO GIUSTO