

S4001.22.1V17.FT

FT

cod. 3121 060

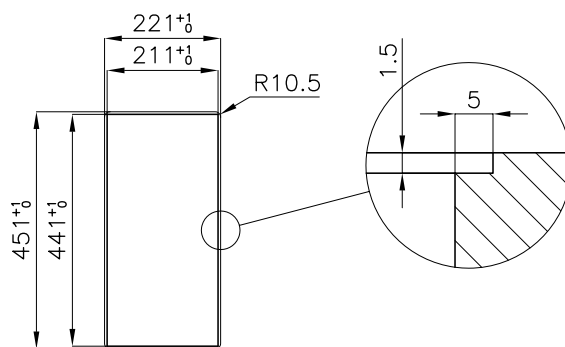
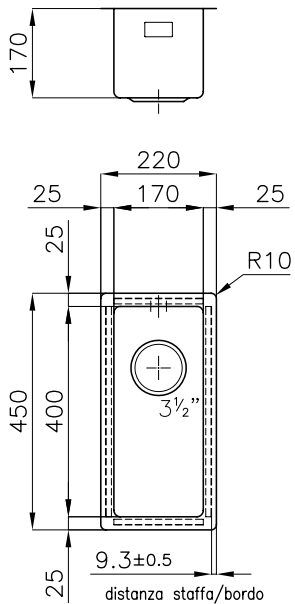

Dimensioni per foratura top

[www.fosterspa.com](http://www.fosterspa.com)