

Marchio / Brand KOS

Classe / Class K-COL

MORPHING COLLECTION

1MP304BI

Vasca in Cristalplant®, a parete. / Back panel to wall bathtub in Cristalplant®.



Vasca in Cristalplant®, con colonna di scarico esterna cromata completa di piletta e sifone.

Versione parete.

Colore bianco.

Dimensioni: 1800 x 800 x h 560 mm

Bathtub in Cristalplant®, complete with chrome waste.

Back panel to wall version.

White color.

Dimensions: 1800 x 800 x h 560 mm

MORPHING COLLECTION

1MP304BI

Disegno Complessivo / Overall Drawing

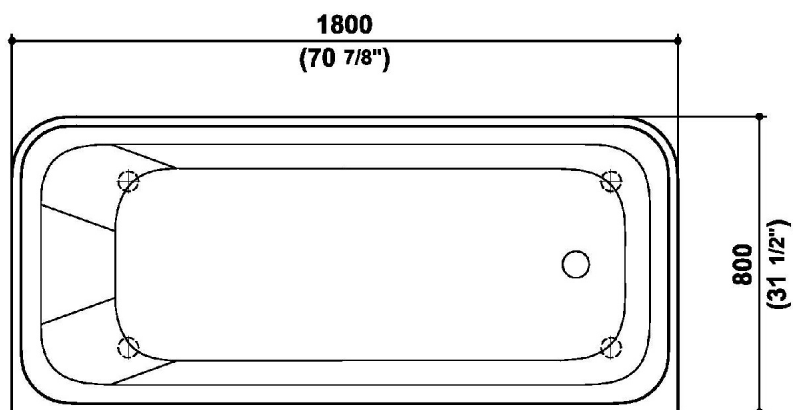
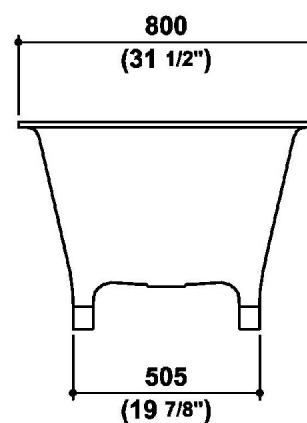
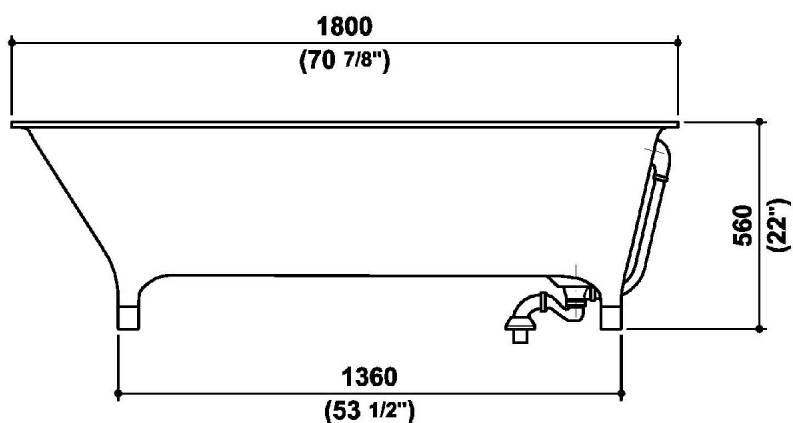

MORPHING COLLECTION

1MP304BI

Dati operativi / Specifications		
Dimensioni / Dimensions	1800 x 800 X 560 mm	70,9 x 31,5 X 22 inc
Marcatura CE / CE Marking	SI	
Peso netto / Net weight	100.00 kg	220.00 lb
Peso operativo / Working weight	350.00 kg	770.00 lb
Capacità / Capacity	100.00 l	26.40 gal

Materiale / Material

Cristalplant / Cristalplant

Pulizia / Cleaning

Manutenzione quotidiana: pulire con acqua saponata o comuni detersivi. Sono consigliati detersivi in gel o abrasivi, avendo cura di risciacquare bene la superficie, da utilizzare con spugna abrasiva tipo Scotch Brite, per mantenere la finitura opaca originale.

Evitare l'utilizzo di prodotti chimici aggressivi quali acetone, trielina, acidi o basi forti.

Alcune sostanze - come inchiostro, cosmetici, tinte - possono rilasciare coloranti sulla superficie, lo stesso per le sigarette accese. Per macchie ostinate, graffi e bruciature si può porre rimedio adoperando una spugnetta abrasiva Scotch Brite con pulitore abrasivo, che levighi la superficie. Se il difetto è ancora visibile ripassare levigando con carta abrasiva molto fine (grana 1200).

Daily maintenance: to clean with soapy water or household detergents. Gel or abrasive detergents are recommended, taking care to thoroughly rinse the surface. When using an abrasive Scotch-Brite pad the original opaque finish, which is the characteristic of Cristalplant, will be maintained.

To avoid the use of aggressive chemical products such as acetone, trielin, strong acids. Some substances such as ink, make-up and dyes, as well as cigarettes may leave stains and marks on the surface.

Scratches, cigarettes burns and stubborn stains can be removed by using an abrasive Scotch-Brite pad and an household abrasive cleaner. If the defect is still visible, repeat repeat the treatment using a very fine sand paper (1200 grain).

MORPHING COLLECTION**1MP304BI** Pesi e Misure / Weights and Sizes

Peso (Kg) Weight (lb)	150,00 (Kg)	330,69 (lb)
Volume (dc3) - (in3)	1343,08 (dc3)	81959,71 (in3)
h (mm) - (in)	760,00 (mm)	29,92 (in)
L1 (mm) - (in)	940,00 (mm)	37,01 (in)
L2 (mm) - (in)	1880,00 (mm)	74,02 (in)

